

XC9223/9224 Series

1A Driver Transistor Built-In Step-Down DC/DC Converters



Preliminary

October 7, 2004 V2

Green Operation Compatible

- Step-Down DC/DC Converters
- Built-in P-channel MOSFET : 0.23Ω
- Built-in Synchronous N-channel MOSFET : 0.25Ω
(No Schottky Barrier Diode Required)
- High Efficiency : 94% (VIN=5.0V, VOUT=3.3V)
- Oscillation Frequency: : 1.0MHz, 2.0MHz
(Small Inductor for High Frequency Selectable)
- Synchronized with an External Clock Signal
- Ceramic Capacitor Compatible
- MSOP-10 / USP-10 Packages

■ GENERAL DESCRIPTION

The XC9223/9224 series are synchronous step-down DC/DC converters with a 0.23Ω (TYP.) P-channel driver transistor and a synchronous 0.25Ω (TYP.) N-channel switching transistor built-in. A highly efficient and stable current can be supplied up to 1.0A by reducing ON resistance of the built-in transistor.

With a high switching frequency of 1.0MHz or 2.0MHz, a small inductor is selectable; therefore, the XC9223/9224 series are ideally suited to applications with height limitation such as HDD or space-saving applications.

Current limit value can be chosen either 1.5A (MIN.) when the LIM pin is high level, or 0.5A (MIN.) when the LIM pin is low level for using the power supply which current limit value differs such as USB or AC adapter. With the MODE/SYNC pin, the XC9223/9224 series provide mode selection of the fixed PWM control or automatically switching current limit PFM/PWM control. As for preventing unwanted switching noise, the XC9223/9224 series can be synchronized with an external clock signal within the range of ± 25% toward an internal clock signal via the MODE/SYNC pin. For protection against heat damage of the ICs, the XC9223/9224 series build in three protection functions: integral latch protection, thermal shutdown, and short-circuit protection.

With the built-in U.V.L.O. (Under Voltage Lock Out) function, the internal P-channel driver transistor is forced OFF when input voltage becomes 1.8V or lower.

The series' detector function monitors the discrecional voltage by external resistors.

■ TYPICAL APPLICATION CIRCUIT

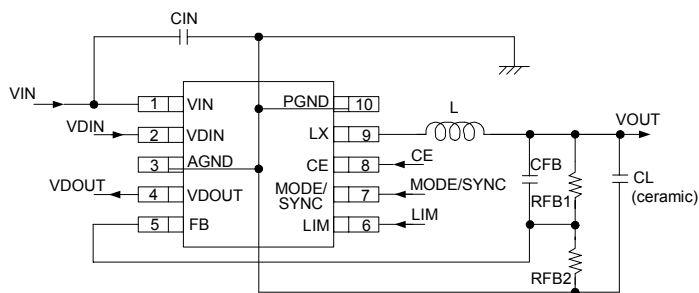

■ APPLICATIONS

- HDD
- Notebook computers
- CD-R / RW, DVD
- PDAs, Portable communication modems
- Digital cameras, Video recorders
- Various general-purpose power supplies

■ FEATURES

- Input Voltage Range : 2.2V ~ 6.0V
- Output Voltage Range : 0.8V ~ VIN
Can be set freely with 0.8V (±2%) of reference voltage by the external resistors.
- Oscillation Frequency : 1MHz, 2MHz (± 15% accuracy)
- Output Current : 1.0A
- Maximum Current Limit : 0.5A (MIN.) when LIM pin='L'
: 1.5A (MIN.) when LIM pin='H'
- Controls : PWM/PFM externally switching
: Synchronized with an external clock signal
- Protection Circuits : Thermal shutdown
: Integral latch method (over current limit)
: Short-circuit protection
- Soft-Start Time : 3mS (TYP.) internally set
- Voltage Detector : 0.712V detect, N-ch open drain output

■ TYPICAL PERFORMANCE CHARACTERISTICS

- Efficiency vs. Output Current

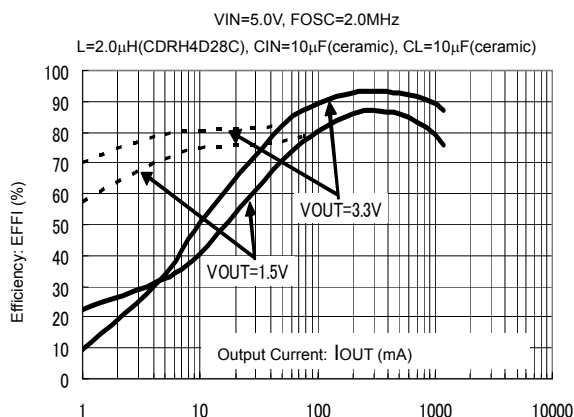

XC9223/9224 Series

1A Driver Transistor Built-In Step-Down DC/DC Converters



Preliminary

PIN CONFIGURATION

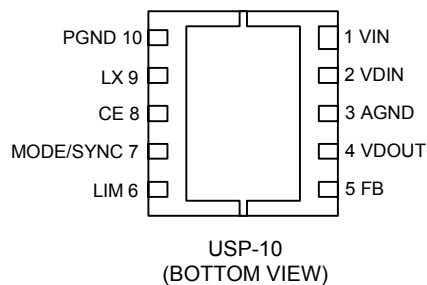
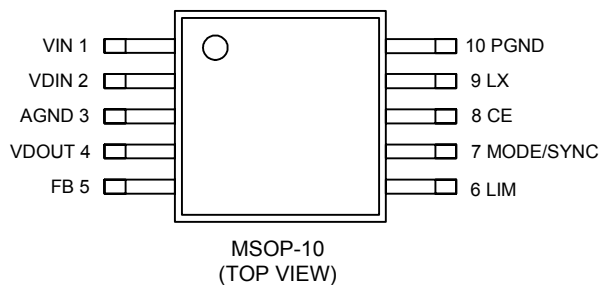

* Please short the AGND pin and the PGND pin (pin no. 3 and 10) before use.

* For mounting intensity and heat dissipation, please refer to recommended mounting pattern and recommended metal mask when soldering the pad of USP-10.

PIN ASSIGNMENT

PIN NUMBER	PIN NAME	FUNCTIONS
1	VIN	Input
2	VDIN	Voltage Detector Input
3	AGND	Analog Ground
4	VDOUT	VD Output
5	FB	Output Voltage Monitor
6	LIM	Over Current Limit Setting
7	MODE/SYNC	Mode Switch / External Clock Input
8	CE	Chip Enable
9	LX	Switch
10	PGND	Power Ground

PRODUCT CLASSIFICATION

Ordering Information

XC9223B ①②③④⑤ <The CE pin is commonly used in the DC/DC block and the VD block.>

XC9224B ①②③④⑤ <No CE pin in the VD block. (The VD block is constantly operated.)>

DESIGNATOR	DESCRIPTION	SYMBOL	DESCRIPTION
① ②	Reference Voltage	08	: Fixed voltage
③	DC/DC Oscillation Frequency	1	: 1.0 MHz
		2	: 2.0 MHz
④	Package	A	: MSOP-10
		D	: USP-10
⑤	Device Orientation	R	: Embossed tape, Standard feed
		L	: Embossed tape, Reverse feed

XC9223/9224 Series

1A Driver Transistor Built-In Step-Down DC/DC Converters



Preliminary

PACKAGING INFORMATION

○ MSOP-10

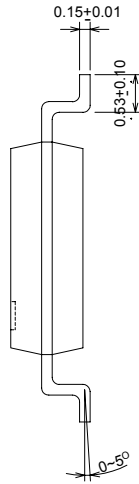
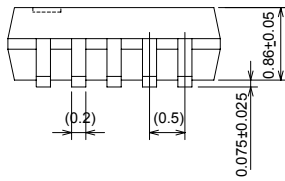
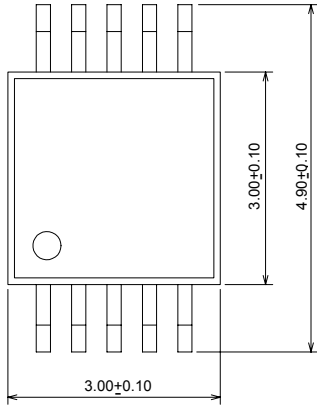

○ USP-10

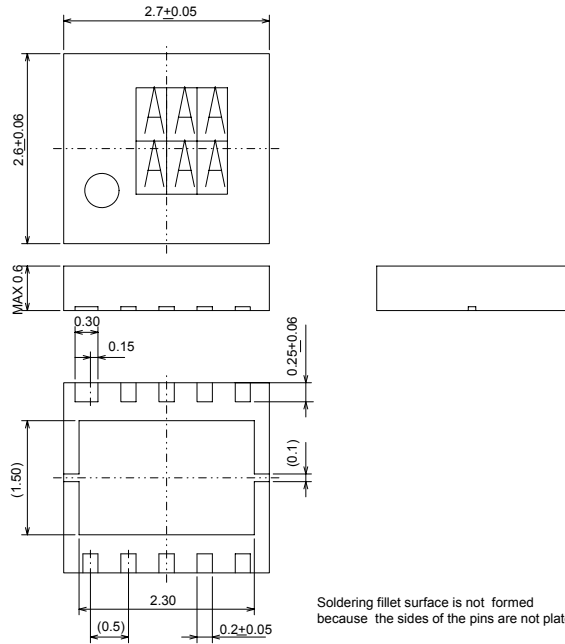

Soldering fillet surface is not formed because the sides of the pins are not plated.

BLOCK DIAGRAM

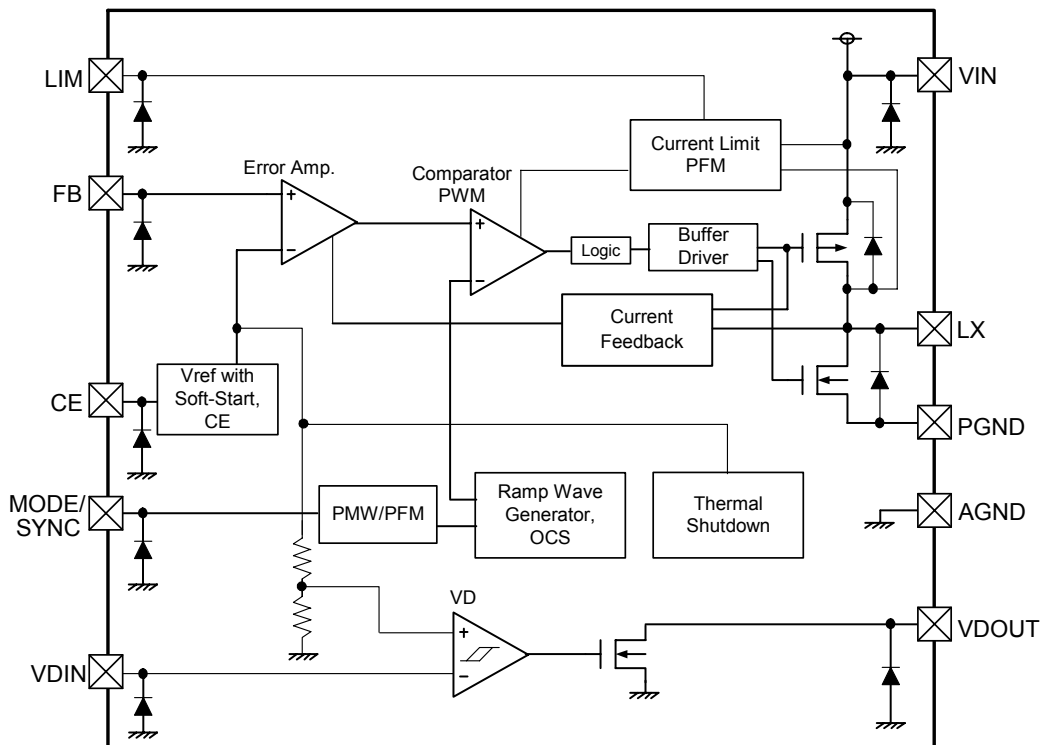

XC9223/9224 Series

1A Driver Transistor Built-In Step-Down DC/DC Converters



Preliminary

■ ABSOLUTE MAXIMUM RATINGS

Ta=25°C

PARAMETER	SYMBOL	RATINGS	UNITS
VIN Pin Voltage	VIN	- 0.3 ~ 6.5	V
VDIN Pin Voltage	VDIN	- 0.3 ~ VDD + 0.3	V
VDOUT Pin Voltage	VDOUT	- 0.3 ~ VDD + 0.3	V
VDOUT Pin Current	IDOUT	50	mA
FB Pin Voltage	VFB	- 0.3 ~ VDD + 0.3	V
LIM Pin Voltage	VLIM	- 0.3 ~ VDD + 0.3	V
MODE/SYNC Pin Voltage	VMODE/SYNC	- 0.3 ~ VDD + 0.3	V
CE Pin Voltage	VCE	- 0.3 ~ VDD + 0.3	V
LX Pin Voltage	VLX	- 0.3 ~ VDD + 0.3	V
LX Pin Current	ILX	2000	mA
Power Dissipation	MSOP-10	Pd	mW
	USP-10		
Operating Temperature Range	Topr	- 40 ~ + 85	°C
Storage Temperature Range	Tstg	- 55 ~ + 125	°C

* When implemented on a PCB.

XC9223/9224 Series

1A Driver Transistor Built-In Step-Down DC/DC Converters



Preliminary

ELECTRICAL CHARACTERISTICS

XC9223B081xx

Topr=25°C

PARAMETER	SYMBOL	CONDITIONS	MIN.	TYP.	MAX.	UNIT	CIRCUIT
Input Voltage	V _{IN}		2.2	-	6.0	V	-
FB Voltage	V _{FB}		0.784	0.800	0.816	V	-
Output Voltage Range	V _{OUTSET}		0.8	-	V _{IN}	V	-
Maximum Output Current (*1)	I _{OUTMAX}		1.0	-	-	A	-
U.V.L.O. Voltage (*2)	V _{UVLO}	FB=V _{FB} x 0.9, Voltage which Lx pin voltage holding "L" level	-	1.8	-	V	-
Supply Current 1	I _{DD1}	FB=V _{FB} x 0.9	-	380	-	μA	-
Supply Current 2	I _{DD2}	FB=V _{FB} x 1.1 (Oscillation stops)	-	30	-	μA	-
Stand-by Current	I _{STB}	CE=0V	-	-	1.0	μA	-
Oscillation Frequency	F _{OSC}	Connected to external components, I _{OUT} =10mA	0.85	1.00	1.15	MHz	-
External Clock Signal Synchronized Frequency	SYN _{COSC}	Connected external components, I _{OUT} =10mA, apply an external clock signal to the MODE/SYNC	0.75	-	1.25	MHz	--
External Clock Signal Duty	SYN _{CDTY}		25	-	75	%	-
Maximum Duty Ratio	MAX _{DTY}	FB=V _{FB} x 0.9	100	-	-	%	-
Minimum Duty Ratio	MIND _{DTY}	FB=V _{FB} x 1.1	-	-	0	%	-
PFM Switch Current	I _{PFM}	Connected to external components, MODE/SYNC=0V, I _{OUT} =0.1mA	-	150	-	mA	-
Efficiency (*3)	EFF _I	Connected to external components, CE=V _{IN} =5.0V, V _{OUT} =3.3V, I _{OUT} =200mA	-	94	-	%	-
Lx SW "H" On Resistance (*4)	R _{LxH}	FB=V _{FB} x 0.9, I _{Lx} =100mA	-	0.23	-	Ω	-
Lx SW "L" On Resistance (*4)	R _{LxL}		-	0.25	-	Ω	-
Current Limit 1	I _{LIM1}	LIM=0V, FB=V _{FB} x 0.9 Current which Lx starts oscillation	0.5	-	-	A	-
Current Limit 2	I _{LIM2}	LIM=V _{IN} , FB=V _{FB} x 0.9 Current which Lx starts oscillation	1.5	-	-	A	-
Integral Latch Time (*5, *6)	T _{LAT}	FB=V _{FB} x 0.9, Short Lx by 1Ω resistance	-	6	-	ms	-
Short Detect Voltage	V _{SHORT}	FB Voltage which Lx becomes "L"	-	0.4	-	V	-
Soft-Start Time	T _{SS}	Connected to external components, CE=0V⇒V _{IN} , I _{OUT} =1mA	-	3	-	ms	-
Thermal Shutdown Temperature	T _{TSD}		-	150	-	°C	-
Hysteresis Temperature	T _{HYS}		-	20	-	°C	-
CE "H" Voltage	V _{CEH}	FB=V _{FB} x 0.9, Voltage which Lx becomes "H" when voltage applied to CE	1.2	-	-	V	-
CE "L" Voltage	V _{CEL}	FB=V _{FB} x 0.9, Voltage which Lx becomes "L" when voltage applied to CE	-	-	0.4	V	-
MODE/SYNC "H" Voltage	V _{MODE/SYNCH}		1.2	-	-	V	-
MODE/SYNC "L" Voltage	V _{MODE/SYNCL}		-	-	0.4	V	-
LIM "H" Voltage	V _{LIMH}		1.2	-	-	V	-
LIM "L" Voltage	V _{LIML}		-	-	0.4	V	-
CE "H" Current	I _{CEH}	V _{IN} =CE=6.0V	-	-	0.1	μA	-
CE "L" Current	I _{CEL}	V _{IN} =6.0V, CE=0V	-0.1	-	-	μA	-
MODE/SYNC "H" Current	I _{MODE/SYNCH}	V _{IN} =CE=MODE/SYNC=6.0V	-	-	0.1	μA	-
MODE/SYNC "L" Current	I _{MODE/SYNCL}	V _{IN} =CE=6.0V, MODE/SYNC=0V	-0.1	-	-	μA	-
LIM "H" Current	I _{LIMH}	V _{IN} =CE=LIM=6.0V	-	-	0.1	μA	-
LIM "L" Current	I _{LIML}	V _{IN} =CE=6.0V, LIM=0V	-0.1	-	-	μA	-
FB "H" Current	I _{FBH}	V _{IN} =CE=FB=6.0V	-	-	0.1	μA	-
FB "L" Current	I _{FBL}	V _{IN} =CE=6.0V, FB=0V	-0.1	-	-	μA	-
Lx SW "H" Leak Current	I _{LxH}	V _{IN} =LX=6.0V, V _{CE} =0V	-	-	1.0	μA	-
Lx SW "L" Leak Current (*7)	I _{LxL}	V _{IN} =6.0V, LX=CE=0V	-1.0	-	-	μA	-

XC9223/9224 Series

1A Driver Transistor Built-In Step-Down DC/DC Converters



Preliminary

■ ELECTRICAL CHARACTERISTICS (Continued)

XC9223B081xx (Continued)

Topr=25°C

PARAMETER		SYMBOL	CONDITIONS	MIN.	TYP.	MAX.	UNIT	CIRCUIT
VOLTAGE DETECTOR	Detect Voltage	VDF	Voltage which VDOOUT becomes "H"↔"L"	-	0.700	-	V	-
	Release Voltage	VDR	Voltage which VDOOUT becomes "L"↔"H"	-	0.745	-	V	-
	Hysteresis Voltage	VHYS	VHYS=(VDR-VDF)/VDF x 100	-	6	-	%	-
	Output Current	IDOUT	VIN=VDF x 0.9, apply 0.5V to VDOOUT	-	2.5	-	mA	-
	Delay Time	TDLY	Time until VDOOUT becomes "L" ↔ "H"	-	2	-	ms	-
	VDIN "H" Current	IVDINH	VIN=CE=VDIN=6.0V	-	-	0.1	μA	-
	VDIN "L" Current	IVDINL	VIN=CE=6.0V, VDIN=0V	-0.1	-	-	μA	-
	VDOOUT "H" Current	IVDOOUTH	VIN=VDIN=VDOOUT=6.0V	-	-	1.0	μA	-
	VDOOUT "L" Current	IVDOOUTL	VIN=VDIN=6.0V, VDOOUT=0V	-1.0	-	-	μA	-

Test Condition: Unless otherwise stated, VIN=3.6V.

NOTE:

- *1: When the difference between the input and the output is small, some cycles may be skipped completely before current maximizes.
If current is further pulled from this state, output voltage will decrease because of P-ch driver ON resistance.
- *2: Including hysteresis operating voltage range.
- *3: $EFFI = \{ (\text{output voltage} \times \text{output current}) / (\text{input voltage} \times \text{input current}) \} \times 100$
- *4: On resistance (Ω)= Lx pin measurement voltage / 100mA
- *5: Time until it short-circuits Lx with GND through 1 Ω of resistance from a state of operation and is set to Lx=Low from current limit pulse generating.
- *6: Integral latch circuit: Latch time may become longer and latch operation may not work when VIN is 3.0V or more.
- *7: When temperature is high, a current of approximately 50 μ A (maximum) may leak.

■ OPERATIONAL EXPLANATION

Each unit of the XC9223/9224 series consists of a reference voltage source, a ramp wave circuit, error amplifier, PWM comparator, phase compensation circuit, output voltage adjustment resistors, P-channel MOS driver transistor, N-channel MOS synchronous rectification switching transistor, current limiter circuit, U.V.L.O. circuit and others. The series compares, using the error amplifier, the internal reference voltage to the CE pin with the voltage feedback from the VOUT pin via resistors RFB1 and RFB2. Phase compensation is performed on the resulting error amplifier output, to input a signal to the PWM comparator to determine the turn-on time during PWM operation. The PWM comparator compares, in terms of voltage level, the signal from the error amplifier with the ramp wave from the ramp wave circuit, and delivers the resulting output to the buffer driver circuit to cause the Lx pin to output a switching duty cycle. This process is continuously performed to ensure stable output voltage. The current feedback circuit monitors the P-channel MOS driver transistor current for each switching operation, and modulates the error amplifier output signal to provide multiple feedback signals. This enables a stable feedback loop even when a low ESR capacitor, such as a ceramic capacitor, is used, ensuring stable output voltage.

<Reference Voltage Source>

The reference voltage source provides the reference voltage to ensure stable output voltage of the DC/DC converter.

<Ramp Wave Circuit>

The ramp wave circuit determines switching frequency. The frequency is fixed internally and can be selected from 1.0MHz and 2.0MHz. Clock pulses generated in this circuit are used to produce ramp waveforms needed for PWM operation, and to synchronize all the internal circuits.

<Error Amplifier>

The error amplifier is designed to monitor output voltage. The amplifier compares the reference voltage with the feedback voltage divided by the internal resistors (RFB1 and RFB2). When a voltage lower than the reference voltage is fed back, the output voltage of the error amplifier increases. The gain and frequency characteristics of the error amplifier output are fixed internally to deliver an optimized signal to the mixer.

XC9223/9224 Series

1A Driver Transistor Built-In Step-Down DC/DC Converters



Preliminary

■ OPERATIONAL EXPLANATION (Continued)

<Current Limit>

The current limiter circuit of the XC9223/9224 series monitors the current flowing through the P-channel MOS driver transistor connected to the Lx pin, and features a combination of the constant-current type current limit mode and the operation suspension mode. For the current limit values, please select the values either from 1.5A (MIN.) when the LIM pin is high level or 0.5A (MIN.) when the LIM pin is low level.

- ① When the driver current is greater than a specific level, the constant-current type current limit function operates to turn off the pulses from the Lx pin at any given time.
- ② When the driver transistor is turned off, the limiter circuit is then released from the current limit detection state.
- ③ At the next pulse, the driver transistor is turned on. However, the transistor is immediately turned off in the case of an over current state.
- ④ When the over current state is eliminated, the IC resumes its normal operation.

The IC waits for the over current state to end by repeating the steps ① through ③. If an over current state continues for several msec and the above three steps are repeatedly performed, the IC performs the function of latching the OFF state of the driver transistor, and goes into operation suspension mode. After being put into suspension mode, the IC can resume operation by turning itself off once and then starting it up using the CE pin, or by restoring power to the VIN pin. Integral latch time may be released from a current limit detection state because of the noise. Depending on the state of a substrate, it may result in the case where the latch time may become longer or the operation may not be latched. Please locate an input capacitor as close as possible.

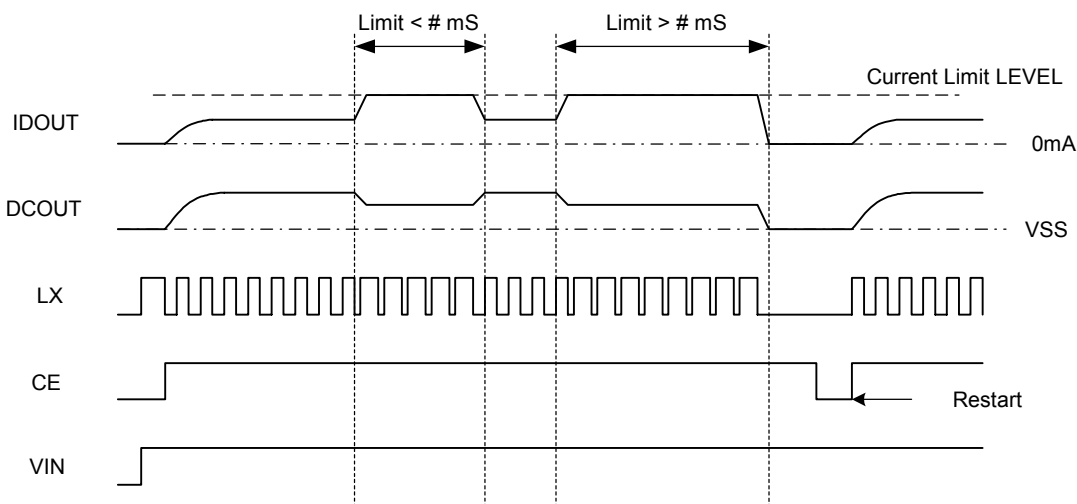

<Thermal Shutdown>

For protection against heat damage of the ICs, thermal shutdown function monitors chip temperature. The XC9223/9224 series build in three protection functions: integral latch protection, thermal shutdown, and short-circuit protection. The thermal shutdown circuit starts operating and the driver transistor will be turned off when the chip's temperature reaches 150°C. When the temperature drops to 130°C or less after shutting of the current flow, the IC performs the soft start function to initiate output startup operation.

<Short-Circuit Protection>

The short-circuit protection circuit monitors FB voltage. In case where output is accidentally shorted to the Ground and when the FB voltage decreases less than half of the FB voltage, the short-circuit protection operates to turn off the driver transistor. In suspension mode, the operation can be resumed by either turning the IC off and on via the CE/MODE pin, or by restoring power supply to the VIN pin.

<Voltage Detector>

The detector block of the XC9223/9224 series detects a signal inputted from the VDIN pin by the VDOUT pin.

<U.V.L.O. Circuit>

When the VIN pin voltage becomes 1.4V or lower, the P-channel output driver transistor is forced OFF to prevent false pulse output caused by unstable operation of the internal circuitry. When the VIN pin voltage becomes 1.8V or higher, switching operation takes place. By releasing the U.V.L.O. function, the IC performs the soft-start function to initiate output startup operation. The soft-start function operates even when the VIN pin voltage falls momentarily below the U.V.L.O. operating voltage.

<MODE/SYNC>

A MODE/SYNC pin has two functions, a MODE switch and an input of external clock signal. The MODE/SYNC pin operates as the PWM mode when applying high level of direct current and the PFM/PWM automatic switching mode by applying low level of direct current, which is the same function as the normal MODE pin. By applying the external clock signal ($\pm 25\%$ of the internal clock signal, ON Duty 25% to 75%), the MODE/SYNC pin switches to the internal clock signal. Also the circuit will synchronize with the falling edge of external clock signal. While synchronizing with the external clock signal, the MODE/SYNC pin becomes the PWM mode automatically. If the MODE/SYNC pin holds high or low level of the external clock signal for several μS , the MODE/SYNC pin stops synchronizing with the external clock and switches to the internal clock operation.